

SR PACKAGING

Advance packaging design via sustainability,
and transcend.



Brand Partners

Shiseido, Laura Mercier, Kao, KOSÉ, bareMinerals, Victoria's Secrets, NARS, REVLON, the list of brands partnering with SR Packaging is long and continues to grow.

ESTÉE LAUDER *Too Faced* COSMETICS NARS REVLON

SHISEIDO Elizabeth Arden NEW YORK VICTORIA'S SECRET

FENTY BEAUTY BY RIHANNA kao shu uemura KOSÉ

ALMAY LAURA MERCIER PARIS | NEW YORK bareMinerals

SUMMER FRIDAYS GLAMGLOW HOLLYWOOD, CALIFORNIA OLEHENRIKSEN

tarte high-performance naturals™ AMERICAN CREW Official Supplier to Men™ POLA HARRY'S

CRABTREE & EVELYN® Bath & Body Works® Bioré

Orveon Edgewell PERSONAL CARE JOSIE MARAN

Walgreens Boots Alliance HUNTER LAB 蘭 L A N

HARRY'S 花西子 Florasis endota LAB SERIES bliss®

One place for innovations and aesthetics

Brands that offer unlimited skincare and beauty solutions for the consumer world are always hungry for innovations and aesthetic designs.

They entrust SR Packaging for new projects, working from concept, packaging application, tooling, decoration to manufacturing, use packaging to protect the delicate formulae and as a medium to maximize brand value and secure customer loyalty.



Brand Partners



Meishoku



Fenty



Summer Fridays



Waphyto

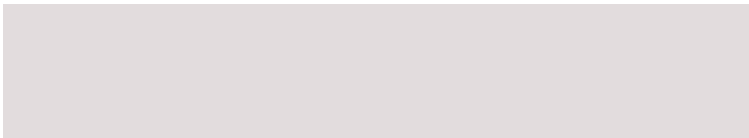

NARS



Revlon



Laura Mercier



IPSY (Item Beauty)



Too Faced



VERSED



Revlon

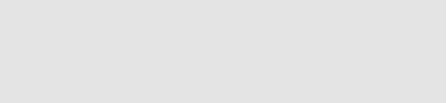

Oursell



C&E



Pola



Shiseido

Decoration Special Treatment



Plastic Colorants

Enables the molded-in color during the molding process.

Apply to     



Spray Coating

Adds a thin layer of glittery sheer, metallic glow, or a UV cured protection on the surface of a component.

Apply to     



Flexo-Printing

Creates high-resolution, poster-quality imagery design with perfect finish.

Apply to 



Offset Printing

Uses plates to transfer ink up to 8 colors, including half-tone and gradation, of artwork requiring precision.

Apply to 

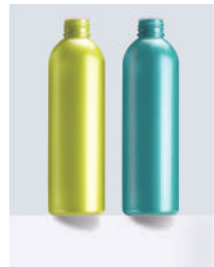

Metalsheen

Allows any PET package to evince metallic luster.

Apply to   



Metallization

Gives a plastic part a shiny, faux-metal finish, with the ability to add more decorations.

Apply to     



Fabric Touch

Mimics the natural fabric texture and adds a warm touch to the tube surface.

Apply to 



Silk Screen Printing



Decorates surface with texts or images of thick, bold, and glossy finish.

Apply to    



Gradients

Gradient, Translucent Gradient, and Vac Met Gradient are achievable with adjustable opacity and translucency.

Gradient Apply to    

Vac Met Gradient Apply to   



Soft Touch

Gives sensational feedback on the fingertips, a matte, frost, tactile touch.

Apply to   



Brushed Metal

Creates a superior, warm and metallic shear for aluminum components in customizable color.

Apply to    



Mold Texturing

Allows for intricate and consistent designs to be added to injection molds for decorative purposes.



Hot Stamping

Enriches a brand image with solid, metallic colors.

Apply to      



Patterned Metalization

Creates a unique pattern by adding over-coatings and UV processing to the known metallization process.

Apply to     

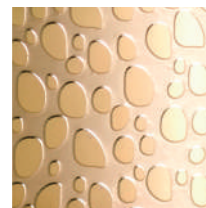

Double Coat Anodizing

Achieves the design with the 3-step process: Anodizing - Silk Screen Print - Anodizing.

Apply to    



Labeling

Enables multiple color decoration to flat surface or cylindrical component.

Apply to    



Marbling Injection

Adds a unique identity for each component, offers aesthetically natural patterns without repetition.

Apply to   

EBM (extrusion blow molding) Airless material options

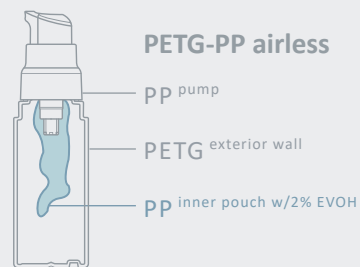
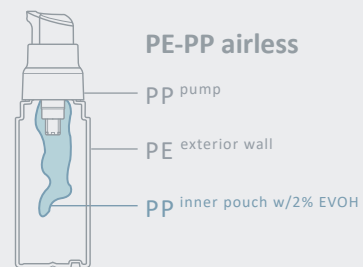
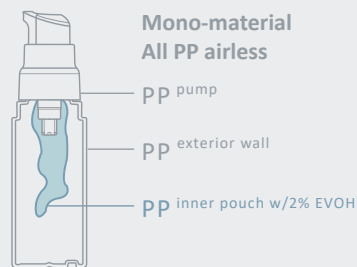

PCR Airless ▶ opt for PCR PE & PCR PP for material option.

Protect Marine Life ▶ opt for recycled PE made of post-use fish nets and fishing gear.



- ACF-030 Maru
- ACF-050 Maru
- ACF-100 Maru
- APA-050 Diamond
- ASA-078 Kaku
- APB-060 Polygon

Ref.	OFC (ml)	H. (mm)	L. / W. (mm)	Neck size	Wt
ACF-030	36.7	75.5	Φ29	20	9g
ACF-050	54	106	Φ29	20	12g
ACF-100	105.5	105	Φ41	24	19g

Ref.	OFC (ml)	H. (mm)	L. / W. (mm)	Neck size	Wt
APA-050	54.5	83	30.5x30.5	20	11g
ASA-078	82	89.9	34.2x34.2	20	13g
APB-060	64.6	94.74	Φ33.54	20	12.5g

More dispensing options on P.25



- ACB-075 Ample
- ACA-072 Alpine
- AOB-030 Tottle
- CHS7081B Burly
- ACI-180B Burly
- ASC-180B Sif

Ref.	OFC (ml)	H. (mm)	L. / W. (mm)	Neck size	Wt
ACB-075	77.5	100	Φ35.5	20	13.5g
ACA-072	75.6	111.1	Φ33.1	20	15g
AOB-030	35	120 (Cap)	36.9x20.8	Special thread	8.5g

Ref.	OFC (ml)	H. (mm)	L. / W. (mm)	Neck size	Wt
CHS7081B	186.3	124.7	Φ50.5	24/410	22.5g
ACI-180B	186.7	127.3	Φ50.5	24/410	23g
ASC-180B	195	158	41x41	24/410	23.5g

Pump: SRP-A050-24C1F21 Pump: SRP-A070-24C85F31



- ACB-180B Aura
- ACA-180B Vesta
- ACD SERIES
- ACD-070B
- ACD-105B
- ACD-150B

Ref.	OFC (ml)	H. (mm)	L. / W. (mm)	Neck size	Wt
ACB-180B	195	129	Φ50	24/410	21.6g
ACA-180B	194	125	Φ50	24/410	22.5g

ACD-B SERIES

Ref.	OFC(ml)	H. (mm)	L. / W. (mm)	Wt
ACD-070B	81	79.9	Φ41.5	12.2g
ACD-105B	114	106.9	Φ41.5	15.5g
ACD-150B	161	143.6	Φ41.5	25g

ACD SERIES

Ref.	H. (mm)	L. / W. (mm)	Match pack	Dosage
ACD-070	118.8 (Cap)	Φ48.6	ACD-070B	1.0 ml
ACD-105	145.8 (Cap)	Φ48.6	ACD-105B	1.0 ml
ACD-150	183.1 (Cap)	Φ48.6	ACD-150B	1.0 ml

ASB-050Z Use the opener to refill ASB & ACH Refillable Airless Bottles.



- ASB SERIES
- ACH SERIES
- ACG SERIES
- ACE-015B
- ACE-030B
- ACE-050B

ASB SERIES

Ref.	H. (mm)	L. / W. (mm)	Match pack	Dosage
ASB-015	100	38x38	ACE-015B	0.23 ml
ASB-030	129.7	38x38	ACE-030B	0.23 ml
ASB-050	149.7	38x38	ACE-050B	0.23 ml

ACG SERIES

Ref.	H. (mm)	L. / W. (mm)	Match pack	Dosage
ACG-015	101.2	Φ43.5	ACE-015B	0.23 ml
ACG-030	130	Φ48.5	ACE-030B	0.23 ml
ACG-050	154	Φ48.5	ACE-050B	0.23 ml

ACH SERIES

Ref.	H. (mm)	L. / W. (mm)	Match pack	Dosage
ACH-015	100.1	Φ39.9	ACE-015B	0.23 ml
ACH-030	130	Φ39.9	ACE-030B	0.23 ml
ACH-050	147	Φ39.9	ACE-050B	0.23 ml

ACE-B SERIES

Ref.	OFC(ml)	H. (mm)	L. / W. (mm)	Wt
ACE-015B	21.7	60	Φ27	5.7g
ACE-030B	35.9	89	Φ27	7.9g
ACE-050B	55.3	113	Φ29	10.5g



CHS3075
RePod

CHS7084L-2
Amari

Ref.	OFC (ml)	H. (mm)	L. / W. (mm)	Dosage	Wt
CHS3075	58	84 (Cap)	Φ68	0.2 ml	107.5g(Cap)

Ref.	OFC (ml)	H. (mm)	L. / W. (mm)	Dosage	Wt
CHS7084L-2	71	110 (Pump)	Φ50	0.2 ml	71.4g(Pump)

Airless Shuttle



CCA-060

CCA-020-1
1/3 SPRAYER

CCA-020
1/3 PUMP

CCB-060

CCB-015
1/4 PUMP

CCC-060

CCC-030B
1/2 PUMP

AIRLESS SHUTTLE

Ref.	H. (mm)	L. / W. (mm)	Wt
CCA-060	116.2 (Cap)	Φ55.92	79g (Cap)
CCB-060	116.2 (Cap)	Φ55.92	79g (Cap)
CCC-060	110 (Cap)	Φ50.09	46.38g (Cap)

CCA-020-1 1/3 SPRAYER / CCA-020 1/3 PUMP

Ref.	OFC (ml)	H. (mm)	L. / W. (mm)	Match pack	Dosage	Wt
CCA-020-1	23.5	106.2	37.52	CCA-060	0.2 ml	15.1g
CCA-020	23.5	106.2	37.52	CCA-060	0.2 ml	15.1g

CCB-015 1/4 PUMP

Ref.	OFC (ml)	H. (mm)	L. / W. (mm)	Match pack	Dosage	Wt
CCB-015	18	106.09	29.91	CCB-060	0.2 ml	11.1g

CCC-030B 1/2 PUMP

Ref.	OFC (ml)	H. (mm)	L. / W. (mm)	Match pack	Dosage	Wt
CCC-030B	34	104.39	45.09	CCC-060	0.2 ml	17.4g

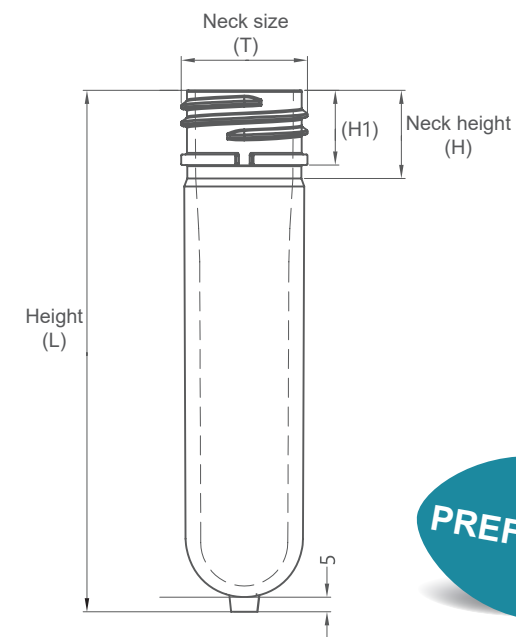

SPEC	Neck size (T)mm	Neck height (H)mm - (H1)mm	Length (L)mm	OFC (V)ml
SRM-R24410-19-093 / 19g	24	410-14	93	100-180
SRM-R24410-25-104 / 25g	24	410-14	104	150-250
SRM-R24410-33-120 / 33g	24	410-14	120	250-400
SRM-R28410-35-108 / 35g	28	410-14.3	108	350-650
Φ18-5g	18	410-13	43	10-25
Φ18-7.8g	18	410-13	61	25-40
Φ18-11g	18	410-13	67	50-90
Φ18-14g	18	410-14.5	90	80-150
Φ20-12g	20	410-12	75	60-90
Φ20-18.5g	20	400/410-10.5/12	92	90-180
Φ20-24g(4)	20	410-12.5	118	150-240
Φ22-26g	22	410-11.5	110	150-250
Φ22-42g	22	410-11.3	126	300-500
Φ24-10g	24	410-14.5	60	50-90
Φ24-16g(4)	24	410-14	70	90-150
Φ24-18g	24	410/RVS Nozzel Head-14.83/12.85	90	100-180
2SRΦ24-20g	24	400Nozzel Head/410-12/14	95	100-200
Φ24-23g	24	410-13.8	83	100-240
2SRΦ24-25g	24	400/410-12/14	118	150-250
Φ24-30g	24	400/410-12/14	116	250-350
Φ24-35g	24	400/410-12/14	130	250-400
Φ24-39g	24	410-12.45	134	300-450
Φ24-42g	24	410/415-14	145	300-500
Φ28-30g	28	400/410-14.5	100	350-600
Φ28-36g	28	410-16.1	108	350-650
Φ28-43g	28	410-16.7	130	400-700
Φ33-18g(4)	33	400-14.5	58	90-150
Φ33-20g(4)	33	400-14.5	65	120-180
Φ33-28g	33	400-18	105	180-350
Φ33-38g	33	400-18	130	300-500
Φ33-54g	33	400-12.5	146	500-1000
Φ38-31.5g	38	400-10.4	100	250-400
Φ40-28g	40	Foam Pump/410-11.75	83	150-350
Φ43-23g	43	Foam Pump-17.2	75	150-350
Φ43-28g	43	Foam Pump-17.5	85.5	150-350
Φ48-14g	48	400(G.F)-9	30.5	50-100
Φ50-16g	50	400(G)-10.2	30.5	50-100
Φ65-40g	65	400-13.5	90	300-500
Φ65-45g	65	400-13.5	90	300-500
Φ67.5-22g	67.5	400(G.F)-11.6	41.5	100-250
Φ70-21g	70	400(G.F)-9.65	35	100-250

SPEC	Neck size (T)mm	Neck height (H)mm - (H1)mm	Length (L)mm	OFC (V)ml
Φ90-27g	90	400(G.F)-11.75	33.5	100-250
Φ90-30g	90	400(G.F)-11.75	45	200-400
Φ90-66g	90	400-19.8	90	1000-1500
Φ106-58g	106	400(G.F)-15	70	500-1000
KSΦ76-46g	76	16.1	44.5	150-200
KSΦ93-72g	93	17.5	70.5	300-500
KJΦ73-46g	73	17.3	54	100-300
KJΦ93-65g	93	17.3	72	350-600

Made-in-America PET bottle supply
4 PET preform sizes for the desired bottle volume

SPEC	Neck size (T)mm	Neck height (H)mm - (H1)mm	Length (L)mm	OFC (V)ml
24/410-19g	24	410	93	100-180
24/410-25g	24	410	104	150-250
24/410-33g	24	410	120	250-400
28/410-35g	28	410	108	350-650

- Customize PET bottles made-in-America
- ★ Custom bottle tooling
 - ★ Hot stamping
 - ★ Gloss finish
 - ★ Labeling
 - ★ Silk screen printing (up to 3 colors)
 - ★ Shrink wrapping



SAC-BB SERIRS

Table with 6 columns: Ref., OFC (ml), H. (mm), L. / W. (mm), Neck size, Wt. Rows include SAC-050BB, SAC-080BB-12g, SAC-080BB-18.5g.

SAD-B SERIES

Table with 6 columns: Ref., OFC (ml), H. (mm), L. / W. (mm), Neck size, Wt. Rows include SAD100-B, SAD120-B.

SYC / SYB-C SERIES

Table with 6 columns: Ref., OFC (ml), H. (mm), L. / W. (mm), Neck size, Wt. Rows include SYC-040, SYC-080, SYB-200C, SYB-250C.

SA-FH / SRB-AFH-B SERIRS

Table with 6 columns: Ref., OFC (ml), H. (mm), L. / W. (mm), Neck size, Wt. Rows include SA-FH150, SA-FH200, SRB-AFH250B, SA-FH250, SA-FH300.

SAC / SRB-AC-B SERIES

Table with 6 columns: Ref., OFC (ml), H. (mm), L. / W. (mm), Neck size, Wt. Rows include SAC090, SAC120, SAC150, SAC180, SAC200, SAC210, SAC250, SAC300, SAC090-B, SRB-AC100B, SAC100-B, SRB-AC120B, SAC120-B, SAC150-B.

SA-F / SRB-AF-B SERIES

Table with 6 columns: Ref., OFC (ml), H. (mm), L. / W. (mm), Neck size, Wt. Rows include SA-F080, SA-F120, SA-F150, SA-F200, SRB-AF500B-2, SA-F250, SRB-AF300B, SA-F300, SRB-AF500B, SA-F500.

SAL SERIES

Table with 6 columns: Ref., OFC (ml), H. (mm), L. / W. (mm), Neck size, Wt. Rows include SAL090, SAL120, SAL150, SAL180, SAL200.

SB-C SERIES

Table with 6 columns: Ref., OFC (ml), H. (mm), L. / W. (mm), Neck size, Wt. Rows include SB-C050, SB-C100, SB-C120, SB-C150, SB-C200.

SBC/ SB / SRB-BC-B SERIES

Table with 6 columns: Ref., OFC (ml), H. (mm), L. / W. (mm), Neck size, Wt. Rows include SRB-BC120B, SBC-120, SBC-150, SB060, SB120, SB180, SB240-410, SB240-415.

SDB SERIES

Table with 6 columns: Ref., OFC (ml), H. (mm), L. / W. (mm), Neck size, Wt. Rows include SDB020, SDB030, SDB040, SDB050.

SH-B SERIES

Table with 6 columns: Ref., OFC (ml), H. (mm), L. / W. (mm), Neck size, Wt. Rows include SH-350B, SH-500B.

SH-F SERIES

Table with 6 columns: Ref., OFC (ml), H. (mm), L. / W. (mm), Neck size, Wt. Rows include SH-F080, SH-F120, SH-F150, SH-F200, SH-F250, SH-F300.

SH-H SERIES

Table with 6 columns: Ref., OFC (ml), H. (mm), L. / W. (mm), Neck size, Wt. Rows include SHH-120, SHH-150, SHH-200.

SH-R / SHR / SH-SR SERIES

Table with 6 columns: Ref., OFC (ml), H. (mm), L. / W. (mm), Neck size, Wt. Rows include SH-R020, SH-R035, SH-R050, SH-R080, SH-R100, SH-R120, SH-R150, SH-R200, SH-R250, SH-R300, SHR-060, SHR-085, SHR-150, SHR-250, SH-SR030, SRP SH035 (ASB).



SRB SERIES

Ref.	OFC (ml)	H. (mm)	L. / W. (mm)	Neck size	Wt
SRB-150	168	128.5	43.2x43.2	24/410	25g
SRB-400	425	172.5	60x60	28/410	43g

SWA SERIES

Ref.	OFC (ml)	H. (mm)	L. / W. (mm)	Neck size	Wt
SWA-200	220	89	Φ70	24/410	23g
SWA-250	270	102	Φ70	24/410	23g

SXA SERIES

Ref.	OFC (ml)	H. (mm)	L. / W. (mm)	Neck size	Wt
SXA-120	122	119.5	56x29	20/410	12g
SXA-150	154	131.5	60.5x31	24/410	20g

SYA SERIES

Ref.	OFC (ml)	H. (mm)	L. / W. (mm)	Neck size	Wt
SYA-150	169	128.6	51x46	24/410	20g
SYA-180	200	145.1	52.5x47	24/410	25g

SYB SERIES

Ref.	OFC (ml)	H. (mm)	L. / W. (mm)	Neck size	Wt
SYB-040	43.5	82.6	38x27	18/410	9g
SYB-080	83	101	46.3x32.6	20/410	12g

SYF SERIES

Ref.	OFC (ml)	H. (mm)	L. / W. (mm)	Neck size	Wt
SYF-080	86	94	70x27	20/410	12g
SYF-150	163	113.4	88x33.2	24/410	16g

SYG SERIES

Ref.	OFC (ml)	H. (mm)	L. / W. (mm)	Neck size	Wt
SYG-150	170	138.2	Φ50.8	24/410	16g
SYG-200	220	162	Φ52.5	24/410	25g

SYH SERIES

Ref.	OFC (ml)	H. (mm)	L. / W. (mm)	Neck size	Wt
SYH-080	80	81	52.5x42	24/410	10g
SYH-150	150	103.8	62x52	24/410	20g

SA /SRB-A-B SERIES

Ref.	OFC (ml)	H. (mm)	L. / W. (mm)	Neck size	Wt
SA010(ASB)	14	59.1	Φ21	18/415	5g
SA010-H14.2	14	59	Φ21	18/410	5g
SA030	37	71.3	Φ30	18/415	7.8g
SA050	53.5	82.5	Φ33	18/415	7.8g
SA060	70	102	Φ33	20/410	12g
SRB-A080B	92	98	Φ40	24/410	19g
SA085	89	98	Φ40	24/410	23g
SA100-415	108	118.5	Φ39.6	24/415	20g
SA120	132	128.1	Φ40.3	24/410	20g
SRP SA125	142	138.5	Φ40	24/410	20g
SA180-410	202	152.8	Φ45	24/410	25g
SA180-415	204	161	Φ45	24/415	25g
SA200	218	145.8	Φ48.1	24/410	25g
SA200-415	221	154	Φ48.1	24/415	25g
SA240	257	181.9	Φ46.2	24/410	30g
SA420	425	195.3	Φ57	24/410	30g
SA28500	507	222.2	Φ57.9	28/410	43g

S-A SERIES

Ref.	OFC (ml)	H. (mm)	L. / W. (mm)	Neck size	Wt
S-030A	33	73.5	Φ30.4	18/410	7.8g
S-110A	116	115.6	Φ43.6	24/410	20g
S-157A	158	130.3	Φ47.8	24/410	25g

S-B SERIES

Ref.	OFC (ml)	H. (mm)	L. / W. (mm)	Neck size	Wt
S-B3030	46	59.5	Φ35.8	30/400	12g
S-B3050	68	82.5	Φ35.8	30/400	13g
S-B3080	95	117	Φ35.8	30/400	23g

SD SERIES

Ref.	OFC (ml)	H. (mm)	L. / W. (mm)	Neck size	Wt
SD060	66	87.5	Φ45.2	20/410	12g
SD120	133	114.5	Φ56	24/410	20g
SD180	196	136.5	Φ63.6	24/410	25g
SD240	260	145.5	Φ71.4	24/410	25g

SE SERIES

Ref.	OFC (ml)	H. (mm)	L. / W. (mm)	Neck size	Wt
SE150	156	141	Φ43	24/410	20g
SE210	216	164	Φ46	24/410	25g

SF / SG SERIES

Ref.	OFC (ml)	H. (mm)	L. / W. (mm)	Neck size	Wt
SF100	108	131.5	49x31	20/415	18.5g
SF250-410	270	169.2	67x41.5	24/410	30g
SF250-415	272	176.7	67x41.5	24/415	30g
SF350	360	192.8	72x47	24/415	35g
SF550	565	207.5	83x52	33/400	54g
SG250	258	178.6	72x60	24/415	28g
SG400	410	216	78x66	24/415	36g

SH / SRB-ASB-B / SRB-RH-B SERIES

Ref.	OFC (ml)	H. (mm)	L. / W. (mm)	Neck size	Wt
SRB-ASB010B	13	52.7	Φ22.3	18/415	5g
SH010(ASB)	13	52.7	Φ22.3	18/410	5g
SH020(ASB)	23	69.7	Φ24	18/410	5g
SH030	33	78.4	Φ27.5	18/410	7.8g
SH045	48	88.3	Φ30	18/410	7.8g
SH050	63	84	Φ35.5	24/410	10g
SH080	81	101.3	Φ36.5	20/410	12g
SH090	95	107.5	Φ38	24/410	10g
SH100	111	118	Φ39.5	20/410	18.5g
SH090-415	93	114	Φ38	24/415	18g
SH120-410	133	132.7	Φ40	24/410	20g
SH120-415	135	141.2	Φ40	24/415	20g
SH150	164	143.6	Φ42.6	24/410	20g
SRB-RH150B	189	153.5	Φ44.2	24/410	25g
SH180	188	153.5	Φ44.2	24/410	25g
SH200	210	153.6	Φ47	24/410	25g
SH250	274	163.6	Φ51.4	24/410	30g
SH280	275	171.8	Φ50.2	24/410	30g
SH300	310	175.1	Φ53.2	24/410	30g
SH400	410	196.2	Φ57.1	24/410	36g
SH500	506	212.4	Φ60	28/410	43g



DSB SERIES

Ref.	OFC (ml)	H. (mm)	L. / W. (mm)	Neck size	Wt
DSB050	56	85.3	30.5x30.5	20/410	12g
DSB100	107	121.8	34x34	20/410	18.5g
DSB150	160	133.8	39x39	20/410	18.5g
DSB200	210	151	42x42	24/410	25g
DSB210	215	153	42x42	24/410	25g
DSB250	263	163.5	45x45	24/410	30g

SRB-AR-B SERIES

Ref.	OFC (ml)	H. (mm)	L. / W. (mm)	Neck size	Wt
SRB-AR100B	106.5	105	Φ41	20/410	15g
SRB-AR150B	160.5	121.1	Φ46	24/410	19g
SRB-AR300B	326	154	Φ58	24/410	33g

Ref.	OFC (ml)	H. (mm)	L. / W. (mm)	Neck size	Wt
SRB-AW050B	70	68.9	Φ42.3	24/410	10g
SRB-YF150B	172.2	140.2	Φ47.4	24/410	32g
SRB-ASB030B	35.7	78.2	Φ28.3	18/410	10g

Ref.	OFC (ml)	H. (mm)	L. / W. (mm)	Neck size	Wt
SRB-Y030B	37	75.5(CAP)	Φ32.2	18/410	8g
SRB-ASB020B	24.5	61.3	Φ28.3	18/410	8g
SRB-A060B-14g	70	91.5	Φ36.1	24/410	14g

DSS/S SERIES

Ref.	OFC (ml)	H. (mm)	L. / W. (mm)	Neck size	Wt
DSS-262A	271	105.3	Φ66.5	24/410	23g
S20080A	112	83	Φ48.8	20/410	12g

SRB-AF-B SERIES

Ref.	OFC (ml)	H. (mm)	L. / W. (mm)	Neck size	Wt
SRB-AF060B	64	87.9	Φ34.9	20/410	11g
SRB-AF120B	139.5	123.8	Φ42.9	24/410	19g
SRB-AF120B-2	140	120.6	Φ43	24/410	19g

SRB-BT-B SERIES

Ref.	OFC (ml)	H. (mm)	L. / W. (mm)	Neck size	Wt
SRB-BT120B	136	115	40x40	Special thread	25g
SRB-BT180B	201	138.5	44x44	Special thread	32g

SRB-AFR-B SERIES

Ref.	OFC (ml)	H. (mm)	L. / W. (mm)	Neck size	Wt
SRB-AFR080B	94.6	97	Φ41	20/410	11g
SRB-AFR120B	137	114	Φ47	20/410	19g
SRB-AFR250B	277	138.7	Φ58	24/410	25g

SRB-AT-B SERIES

Ref.	OFC (ml)	H. (mm)	L. / W. (mm)	Neck size	Wt
SRB-AT120B	136	121	Φ43	Special thread	25g
SRB-AT180B	201	144.5	Φ47	Special thread	32g

SRB-AFH-B SERIES

Ref.	OFC (ml)	H. (mm)	L. / W. (mm)	Neck size	Wt
SRB-AFH030B	36.5	73.03	Φ30.23	20/410	9g
SRB-AFH120B	128.1	134.24	Φ39.37	20/410	18.5g

Orifice Reducer Plug



Ref.	OFC (ml)	H. (mm)	L. / W. (mm)	Neck size	Wt
SRB-AR200B	212	139.5	Φ49	24/410	25g
SRB-H150B-2	170.4	125.5	Φ47.2	24/410	32g
SRB-AFR150B	174.3	120	Φ50.3	24/410	22g

Ref.	OFC (ml)	H. (mm)	L. / W. (mm)	Neck size	Wt
SRB-AF200B-2	231	143	Φ50	24/410	27g
SRB-AF020B	34	75	Φ27.5	20/410	6g
SRB-AF100B-1	108.5	100.05	Φ42.3	24/410	19g



S018050A S20050 S20090-1 S20095 S20100-1 S20100-2 S20120-1 S20120-2 S020125A

Ref.	OFC (ml)	H. (mm)	L. / W. (mm)	Neck size	Wt
S018050A	61	122.1(CAP)	36.5x31.5	18/410	9g
S20050	58	95.3	42x26.6	20/410	12g
S20090-1	90	110.3	47.6x30	20/410	18.5g
S20095	102	111.4	45.9x38	20/410	18.5g
S20100-1	103	112.5	55.6x31.5	20/410	18.5g

Ref.	OFC (ml)	H. (mm)	L. / W. (mm)	Neck size	Wt
S20100-2	103	107.8	Φ41	20/410	18.5g
S20120-1	132	122.3	54.4x35.2	20/410	18.5g
S20120-2	124	127	56x36	20/410	18.5g
S020125A	140	128.9	52.6x32.6	20/415	18.5g



S24100A S24120 S24165 S24230-2 S24250-2 S24300 SX24300

Ref.	OFC (ml)	H. (mm)	L. / W. (mm)	Neck size	Wt
S24100A	108	108	39.5x39.5	24/415	16g
S24120	125	113.5	54x31	24/400	20g
S24165	200	161.5	54.5x39.5	24/410	25g
S24230-2	236	166.5	60x33	24/410	25g

Ref.	OFC (ml)	H. (mm)	L. / W. (mm)	Neck size	Wt
S24250-2	263	127	Φ64	24/410	25g
S24300	306	196.5	Φ50	24/410	30g
SX24300	310	152.5	73.9x46.5	24/410	30g



S40500B S33600 S33800-2 SX28400 S43100-28g S43160A

Ref.	OFC (ml)	H. (mm)	L. / W. (mm)	Neck size	Wt
S40500B	530	133.5	104x68	40/400	28g
S33600	600	151	96x72	33/400	54g
S33800-2	830	196.8	94.6x73	33/400	54g

Ref.	OFC (ml)	H. (mm)	L. / W. (mm)	Neck size	Wt
SX28400	410	209.1	69x45.6	28/415	43g
S43100-28g	154	105.5	Φ48	43/400	28g
S43160A	190	125	Φ48	43/400	28g

HEAVY-WALL SERIES Opt for CRR, chemically recycled resin, same clarity as virgin plastic.



H-A SERIES H-B SERIES H-120C H-070C GH SERIES SRJ-S066 SERIES SRJ-S077-100 SRJ-S045-030

H-A SERIES

Ref.	OFC (ml)	H. (mm)	L. / W. (mm)	Neck size	Wt
H-040A	45	90	Φ31	18/410	19g
H-060A	70	100.5	Φ35.7	20/410	24g
H-120A	142	142.8	Φ41	24/410	36g
H-150A	173	151	Φ44	24/410	45g

GH PETG SERIES

Ref.	OFC (ml)	H. (mm)	L. / W. (mm)	Neck size	Wt	Material
GH-08	9.3	27.5	Φ36.3	Φ32mm	17.5g	PETG
GH-15	17.5	33	Φ42.3	Φ38mm	26.5g	PETG
GH-30	35	37	Φ52.3	Φ48mm	38.5g	PETG
GH-50	52.5	37	Φ61.4	Φ58mm	47.7g	PETG

H-B SERIES

Ref.	OFC (ml)	H. (mm)	L. / W. (mm)	Neck size	Wt
H-040B	45.5	87.5	Φ34	18/410	19g
H-060B	71	109	Φ36	20/410	24g
H-120B	146	138.8	Φ44	24/410	36g
H-150B	175	151.7	Φ46	24/410	45g

SRJ-S066 SERIES

Ref.	OFC (ml)	H. (mm)	L. / W. (mm)	Neck size	Wt	Material
SRJ-S066-060	81	46.9 (CAP)	Φ71.9	Φ66	95.2g	PET or PETG
SRJ-S066-100	114	59 (CAP)	Φ71.9	Φ66	115.2g	PET or PETG

H-C SERIES

Ref.	OFC (ml)	H. (mm)	L. / W. (mm)	Neck size	Wt
H-070C	84	89	Φ44	18/415	19g
H-120C	135	123	Φ44	24/410	36g
H-150C	166	147.8	Φ44	24/410	45g

SRJ-S077-100 / SRJ-S045-030

Ref.	OFC (ml)	H. (mm)	L. / W. (mm)	Neck size	Wt	Material
SRJ-S077-100	110	37.4 (CAP)	Φ80.3	77/400	41.5g	AS
SRJ-S045-030	35	48.6 (CAP)	Φ53.15	45/400	47.5g	PETG



Cap : SRB-BC120-A2



SRB-EFH-B SERIES

SRB-EB150B

BCA-160B

BCC-250B

SRB-EFH-B SERIES

Ref.	OFC (ml)	H. (mm)	L. / W. (mm)	Neck size	Wt
SRB-EFH050B	65	88.4	Φ35.8	24/410	10.5g
SRB-EFH100B	115	110	Φ42	24/410	16.2g

Ref.	OFC (ml)	H. (mm)	L. / W. (mm)	Neck size	Wt
SRB-EB150B	165	137	40*40	24/410	22g
BCA-160B	186	124.5	Φ50.5	24/410	19g
BCC-250B	266	139	Φ56	24/410	24g

Single Layer : PE
Double Layer : PP+PP or PE+PP

Single Layer : PE
Double Layer : PE+PP

Single Layer : PP or PE
Double Layer : PP+PP or PE+PP



SRB-EA250B

SRB-EA150B

SRB-EP-B SERIES

SRB-EA250B SERIES

Ref.	OFC (ml)	H. (mm)	L. / W. (mm)	Neck size	Wt
SRB-EA250B	265	160	Φ50.8	24/410	22g

SRB-EA150B SERIES

Ref.	OFC (ml)	H. (mm)	L. / W. (mm)	Neck size	Wt
SRB-EA150B	166	132	Φ44.75	24/410	17g

SRB-EP-B SERIES

Ref.	OFC (ml)	H. (mm)	L. / W. (mm)	Neck size	Wt
SRB-EP030B	35.5	64.7	Φ32	Special thread	5.6g
SRB-EP060B	69	84.7	Φ38	Special thread	8.5g

Bottle Material			Cap Material
Single Layer	Double Layer		ABS+PP
PP or PE	PE+PP	PP+PP	



SCREW CAP

Apply to:
24C-SA40: DSA085 , DSA100 , DSA125
24C-SA44: DSA150 , DSA200

SPEC

Material	PP	
Neck Size	24/410	
Item No.	Height	Width
24C-SA40	33 mm	Φ40 mm
24C-SA44	45 mm	Φ47 mm

SCREW CAP

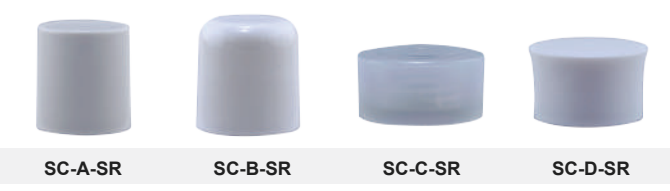

SC-A-SR	SC-B-SR	SC-C-SR	SC-D-SR
Neck size	Neck size	Neck size	Neck size
24/410	20/410 24/410	24/410	24/410

DISC CAP



DC-A-WE	DC-B-WE	DC-C-WE	DC-D-WE
Neck size	Neck size	Neck size	Neck size
18/410 20/410 24/410 18/415 24/415 28/415	18/410 20/410 24/410	24/410 28/410 24/415 28/415	24/415

FLIP-TOP CAP



FT-A-WE	FT-B-WE	FT-C-WE
Neck size	Neck size	Neck size
20/410 24/410 28/410 28/415	18/415 20/415 24/415 28/415	24/410



SPRAYER
18/410 Dosage 0.15 ml

Configurable components



SPRAYER
20/410 Dosage 0.18 ml



SPRAYER
24/410 Dosage 0.18 ml



PUMP / LOTION
18/410 Dosage 0.15 ml



PUMP / LOTION
20/410 Dosage 0.18 ml



PUMP / LOTION
24/410 Dosage 0.18 ml



PUMP / OIL
18/410 Dosage 0.15 ml



PUMP / OIL
20/410 Dosage 0.18 ml





PUMP / JET
18/410 Dosage 0.15 ml



PUMP / LOTION
20/410 Dosage 0.18 ml



PUMP / JET
20/410 Dosage 0.18 ml



HEAT AND COLD TEMPERATURE RESISTANT PUMP

Dosage 1 ml

PUMP / LOTION
24/410 Dosage 0.18 ml



PUMP / JET
24/410 Dosage 0.18 ml



PUMP / LOTION
18/410 Dosage 0.15 ml



EXTERNAL SPRING
Dosage 0.2 ml

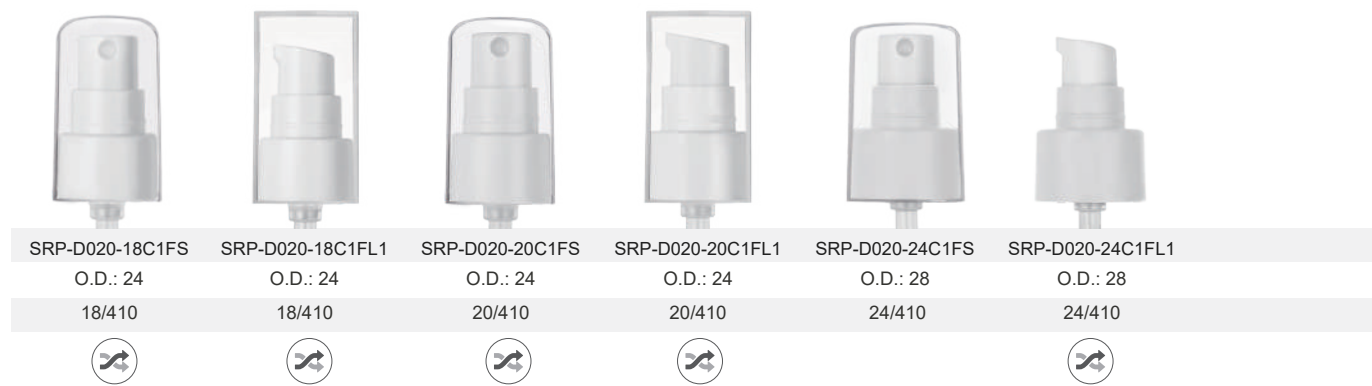



BACK SUCTION PUMP (EXTERNAL SPRING)

Dosage 1.0 ml	Dosage 1.0 ml	Dosage 1.0 ml	Dosage 1.0 ml
SRP-N100-24C5F1	SRP-N100-24C2F1	SRP-N100-24C5F2	SRP-N100-24C2F2
O.D.: 28	O.D.: 28	O.D.: 28	O.D.: 28
24/410	24/410	24/410	24/410

AIRLESS PUMP | Match with EBM Airless Bottles on P.4~P.5

Dosage 1.0 ml	Dosage 1.0 ml	Dosage 1.0 ml	Dosage 1.0 ml
SRP-A100-24C5F1	SRP-A100-24C2F1	SRP-A100-24C5F2	SRP-A100-24C2F2
O.D.: 28	O.D.: 28	O.D.: 28	O.D.: 28
24/410	24/410	24/410	24/410

BACK SUCTION PUMP

PATENT. 200920213472.X

Dosage 0.5 ml	Dosage 0.7 ml			
SRP-D050-24C1F21	SRP-D070-24C85F31	A SERIES	B SERIES	C SERIES
O.D.: 28	O.D.: 29	O.D.: 28	O.D.: 28	O.D.: 28
24/410	24/410	24/410	24/410	24/410

A		B		C	
Ref.	Dosage	Ref.	Dosage	Ref.	Dosage
SRP-D100-24C5F1	1.0 ml	SRP-D100-24C2F1	1.0 ml	SRP-D100-24C5F2	1.0 ml
SRP-D070-24C5F1	0.7 ml	SRP-D070-24C2F1	0.7 ml	SRP-D070-24C5F2	0.7 ml

AIRLESS PUMP (EXTERNAL SPRING)

Dosage 0.5 ml	Dosage 0.7 ml	Dosage 0.2 ml	
SRP-A050-24C1F21	SRP-A070-24C85F31	SRP-A020-24C1FS	MATCH BOTTLE ACI-180B
O.D.: 28	O.D.: 29	I.D.: 24/410 O.D.: 28	
24/410	24/410		

D SERIES	E SERIES	F SERIES	G SERIES
O.D.: 28	O.D.: 28	O.D.: 28	O.D.: 28
24/410	24/410	24/410	24/410

D		E		F		G	
Ref.	Dosage	Ref.	Dosage	Ref.	Dosage	Ref.	Dosage
SRP-D100-24C2F2	1.0 ml	SRP-D100-24H1F1	1.0 ml	SRP-D100-24H1F2	1.0 ml	SRP-D100-24C5F5	1.0 ml
SRP-D070-24C2F2	0.7 ml	SRP-D070-24H1F1	0.7 ml	SRP-D070-24H1F2	0.7 ml	SRP-D070-24C5F5	0.7 ml

AIRLESS PUMP (EXTERNAL SPRING)

20/410 AIRLESS PUMP

Dosage 0.2 ml	Dosage 0.2 ml	Dosage 0.18 ml		
SRP-A020-20C21FL1	SRP-A020-20C21FS	SRP-A018-20H3FO	SRP-A018-20H3FL2	SRP-A018-20H3FL1
I.D.: 20 / O.D.: 24	I.D.: 20 / O.D.: 26(Cover)	O.D.: 24	O.D.: 24	O.D.: 24
MATCH BOTTLE				
ACF-030 / ACF-050 / APA-050 / ASA-078 / APB-060 / ACB-075 / ACA-072				



EXTRUDING MACHINE

SINGLE LAYER TUBE

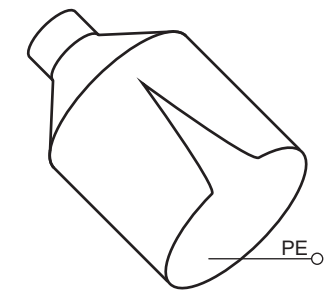

2 LAYER TUBE

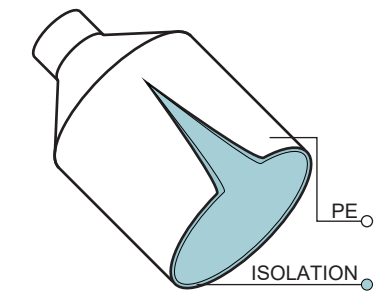

5 LAYER TUBE

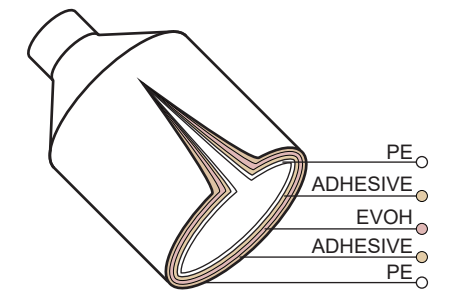

TUBE DIAMETER & TUBE SHAPE COMPARATIVE TABLE

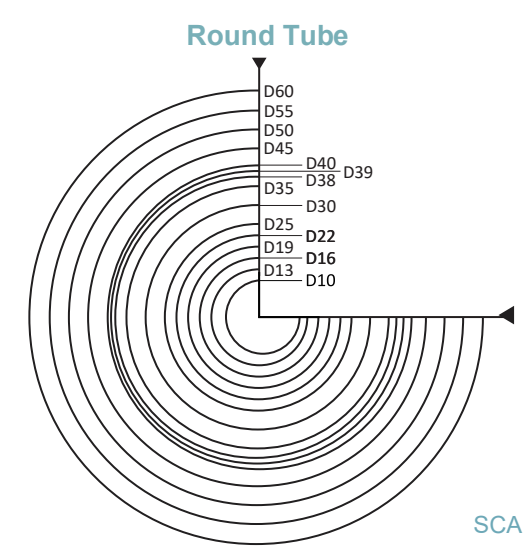
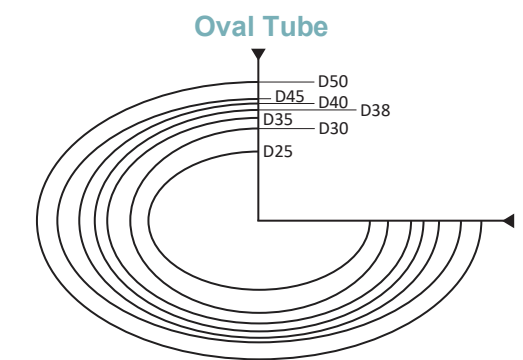
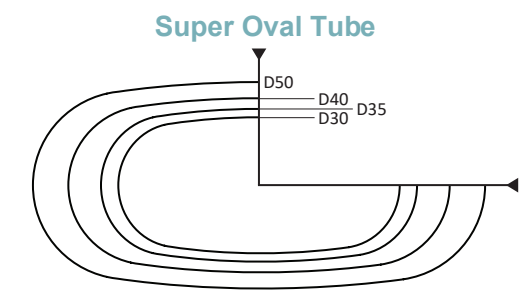

TUBE CAPACITY TABLE

Φ	Capacity /ml	Length /mm	Φ	Capacity /ml	Length /mm	Φ	Capacity /ml	Length /mm
10	2	40	35	95	140	50	135	114
	3	60		100	145		140	117
	5	80		110	150		145	120
13	3	50	120	155	150	123		
	5	60	125	160	155	126		
16	8	85	130	165	160	129		
	5	65	60	95	165	132		
	8	70	65	98	170	135		
19	10	75	70	100	175	138		
	15	100	75	105	180	141		
	10	55	80	110	185	144		
22	15	80	85	115	190	147		
	20	95	90	120	195	150		
	10	70	95	125	200	153		
25	15	77	100	130	210	159		
	20	85	110	135	220	165		
	25	105	120	140	230	171		
	30	110	125	145	240	177		
	20	70	130	150	250	183		
	25	80	135	155	260	189		
30	30	90	140	160	175	123		
	35	100	145	165	180	126		
	40	110	150	170	185	129		
	45	120	100	105	190	133		
	50	130	110	115	195	137		
	30	75	120	125	200	140		
35	35	82	125	130	210	147		
	40	90	130	145	220	154		
	45	98	135	150	230	161		
	50	105	140	155	240	168		
	55	113	145	160	250	175		
	60	121	150	165	260	182		
40	65	129	155	170	200	120		
	70	137	160	175	210	125		
	50	95	165	180	220	130		
	55	100	170	185	230	135		
	60	105	175	190	240	140		
	65	110	180	195	250	145		
45	70	115	100	95	260	150		
	75	120	110	100	270	155		
	80	125	120	105	280	160		
	85	130	125	108	290	165		
	90	135	130	111	300	185		
				130	111	400	200	

SCALE 1:1

ALUMINUM

POLYLAMI

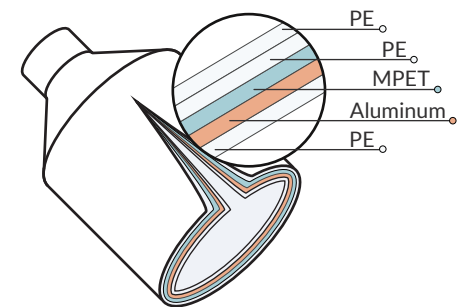

SILVER ABL TUBE

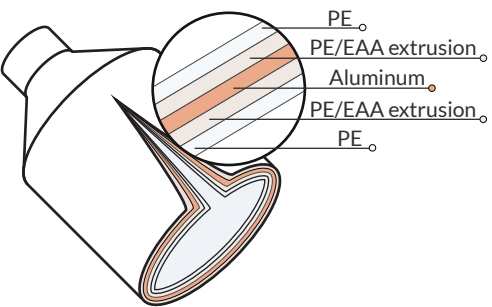

WHITE ABL TUBE

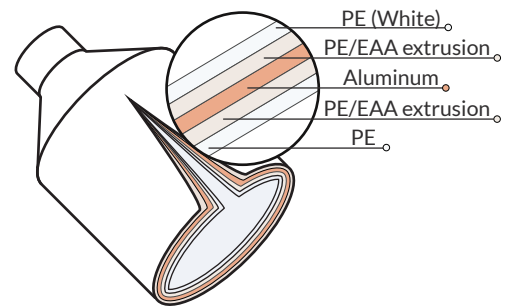



Screw Head Tube

Configurable components

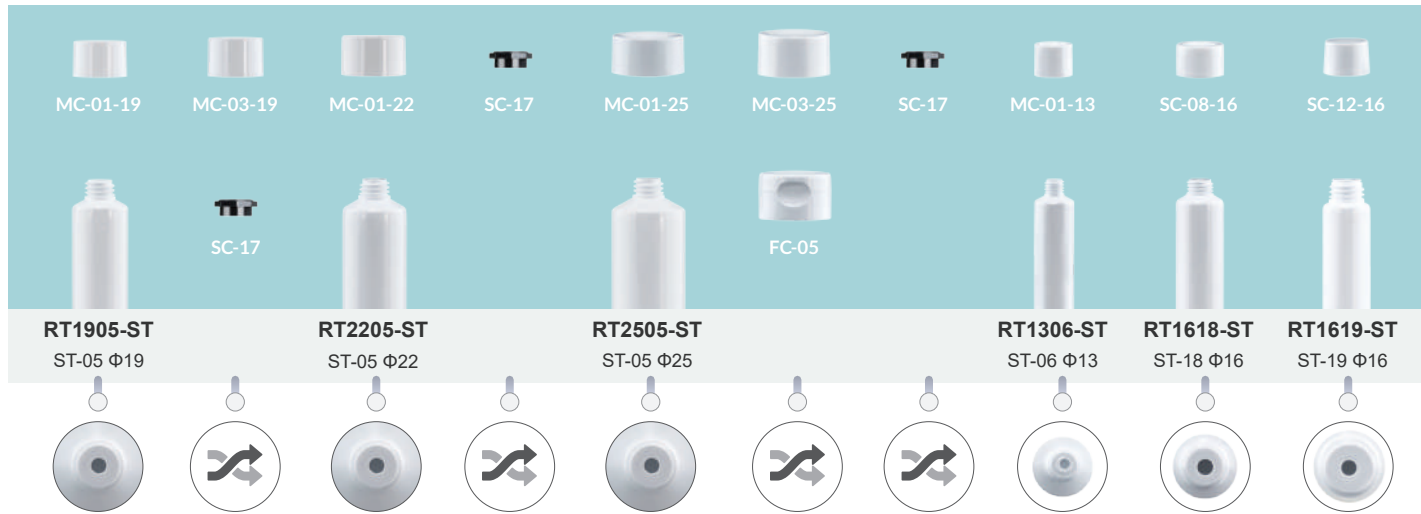

Cosmetic Applicator Tube

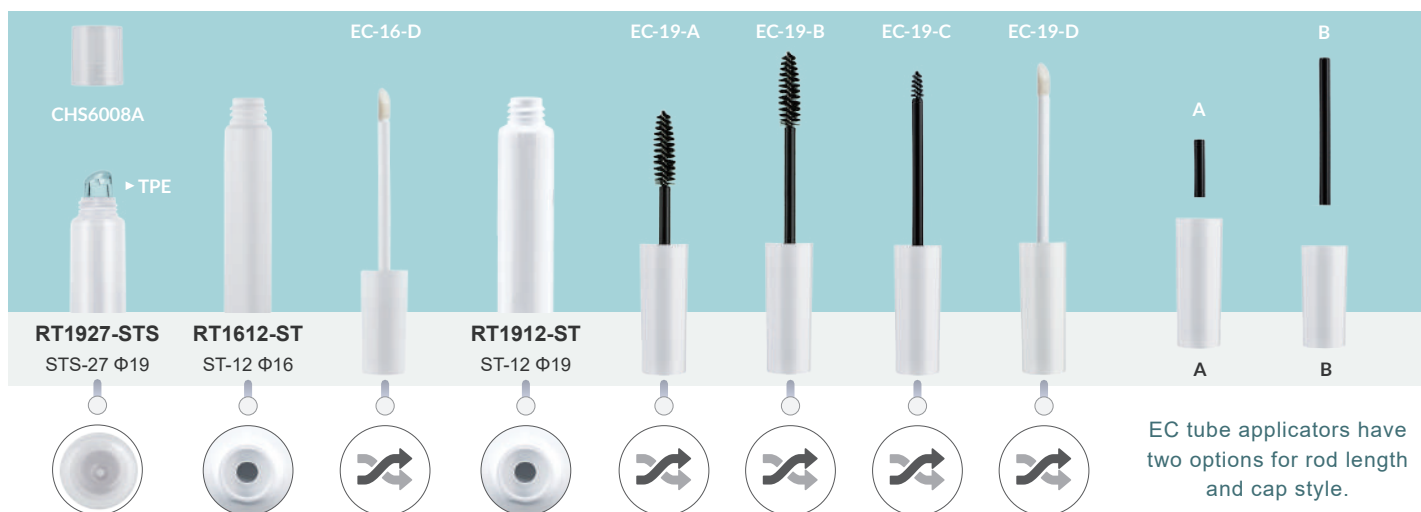
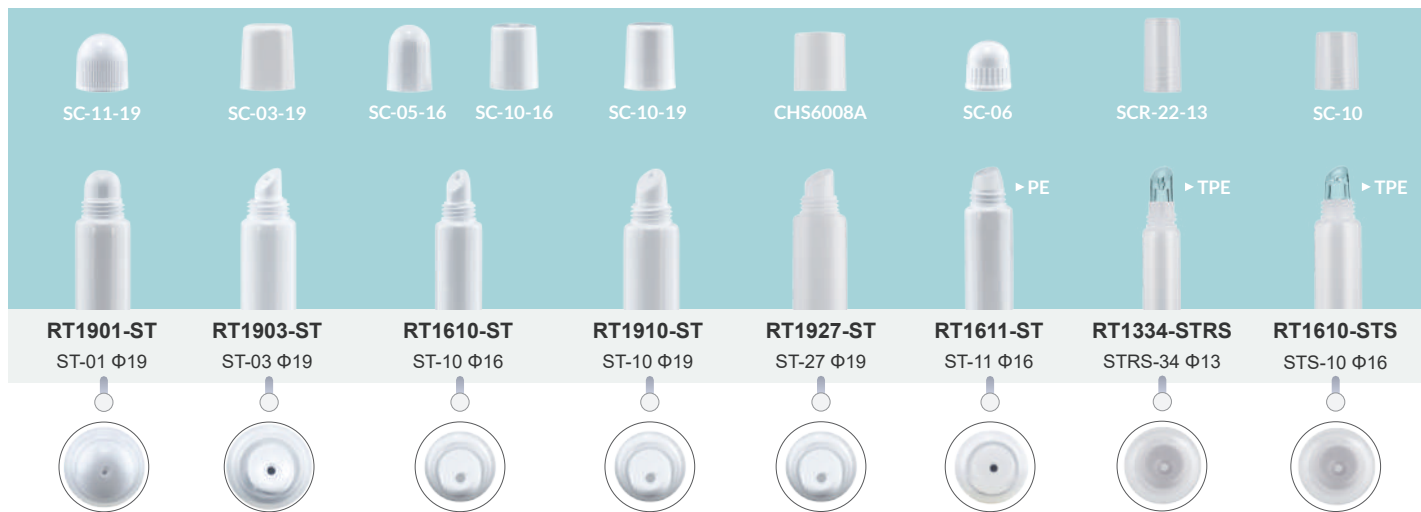

ST / MT SERIES - ROUND TUBE

Nozzle Tube

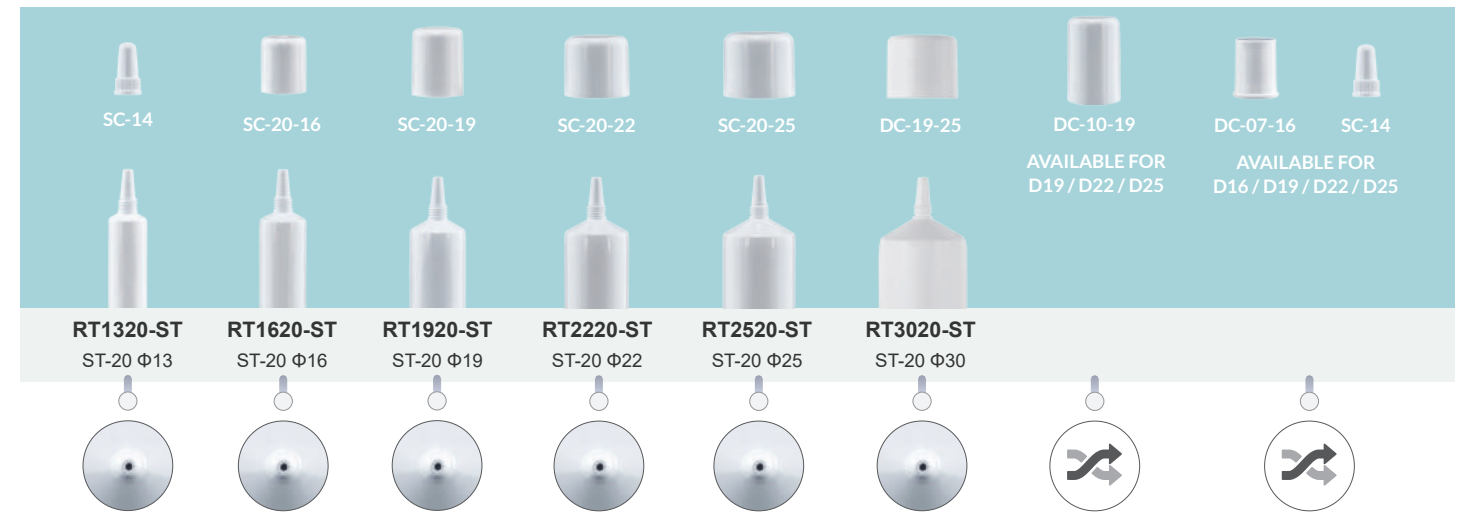

Common Style





Configurable components



Large Aperture Style

Small Aperture Style

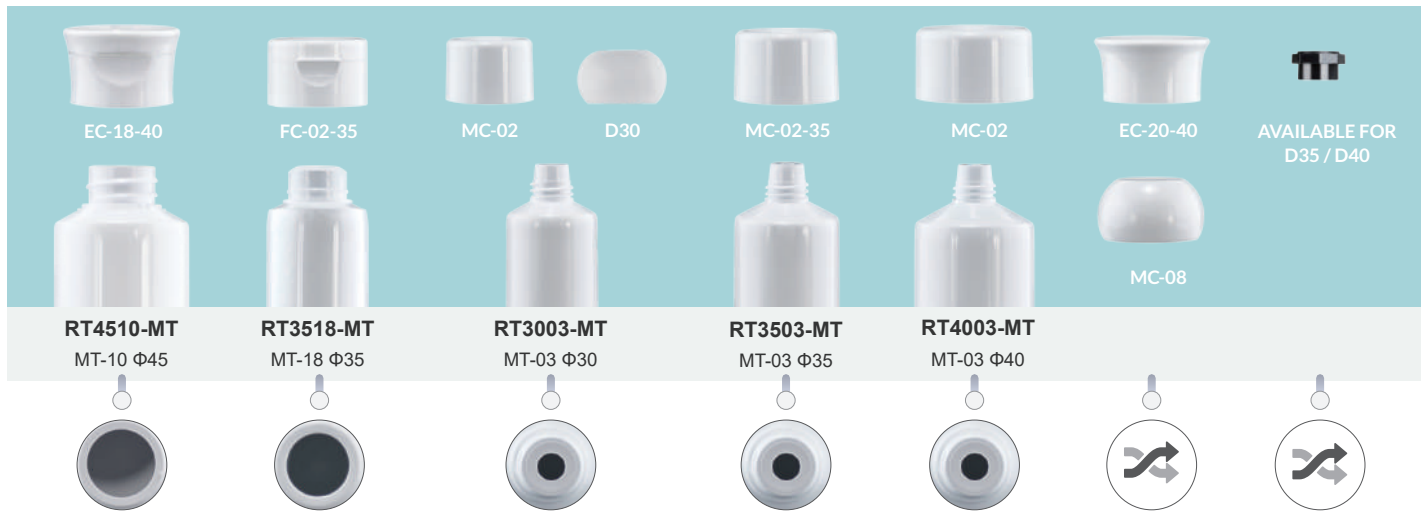

Nozzle Tube

Roller Ball Style

SILICA GEL

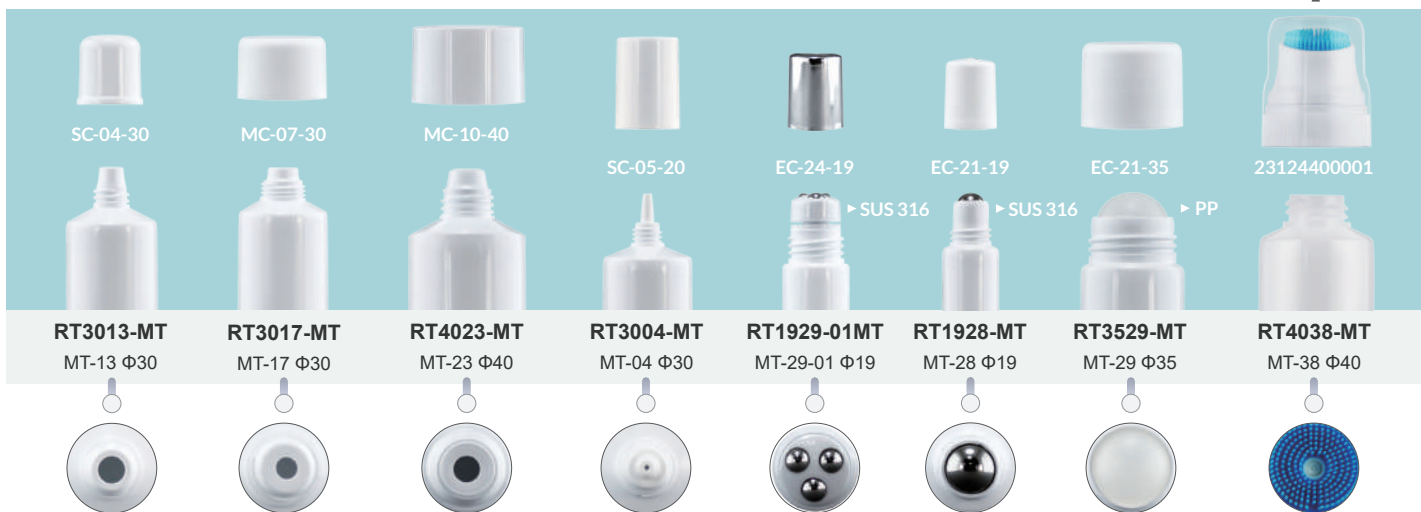

Common Style



Twist-lock Dispensing Tube

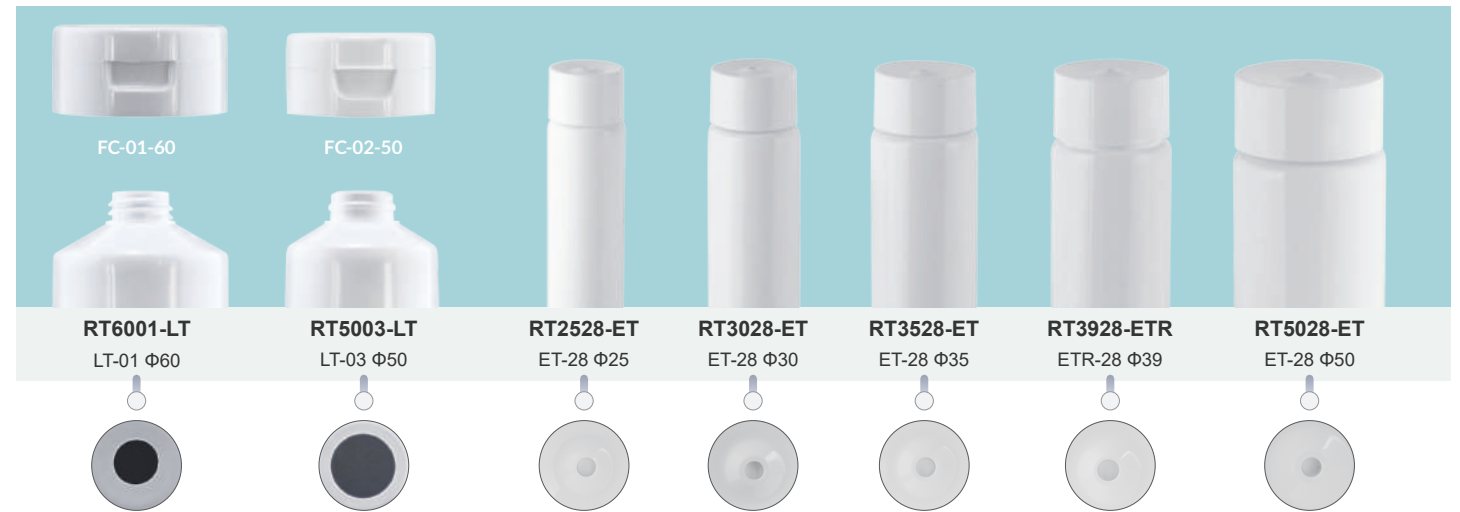

Snap-off Tube

Oval Tube : Common Style

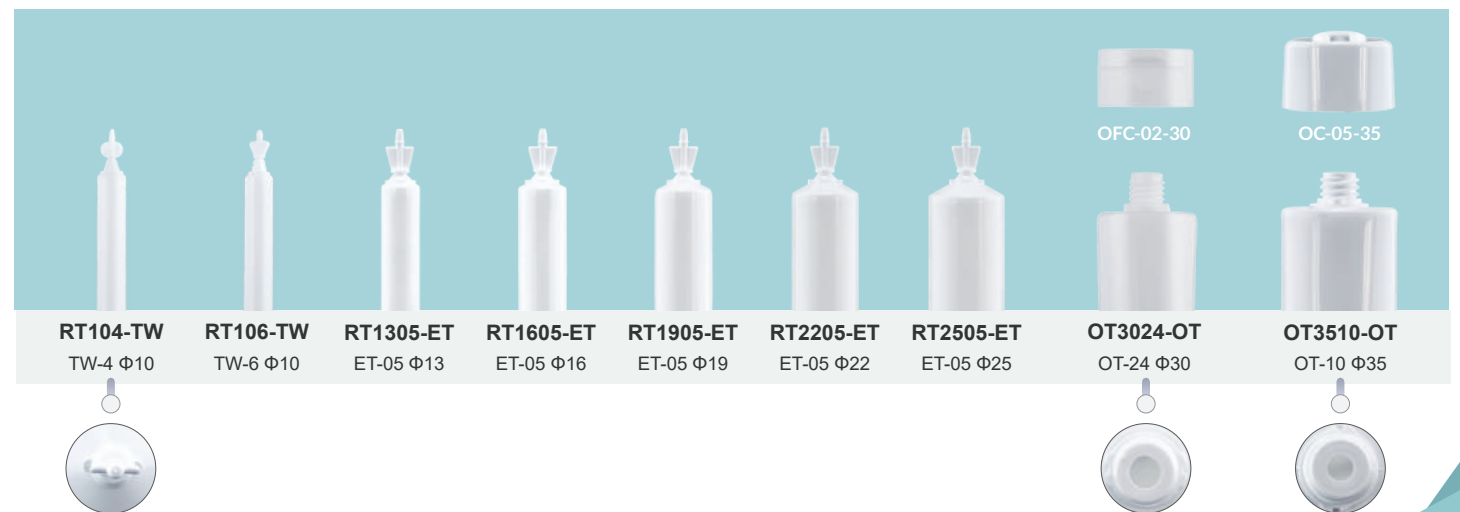



Configurable components



Oval Tube : Small Aperture Style



Oval Tube : Nozzle Tube



Super Oval Tube : Small Aperture Style



Oval Tube : Dual Chamber Style





Oval Tube

Round Tube

Round Tube

New Cover:SAN



SRP-A020-15C1FS
I.D.: 15/ O.D.: 36 (Cover)
15/410 - D30
Dosage 0.2 ml
EOT-09-01

ET-ZL



RT30ZL-ET
D30, 35, 40mm
Material: PP
Dosage 0.25 ml
LT-07

Dosage 0.25 ml



RT3007-LT-166
LT-07 Φ30

Round Tube



RT3008-ET	RT3008-ET	RT3508-ET	RT4008-ET
ET-08 Φ25	ET-08 Φ30	ET-08 Φ35	ET-08 Φ40

	Applicable	Dosage
A	Φ25/Φ30/Φ35	0.25 ml
B	Φ25/Φ30/Φ35	0.25 ml
C	Φ25/Φ30/Φ35	0.25 ml

	Applicable	Dosage
D	Φ30/Φ35/Φ40	0.25 ml
E	Φ30/Φ35/Φ40	0.25 ml

Made-in-America tube supply 4 thread types and 6 closure styles for the desired applications.



Customize tubes made-in-America

- ★ Custom Color Matching.
- ★ Finish, glossy or matte.
- ★ Silkscreen printing, up to 3 colors.
- ★ Hot stamping.
- ★ Tamper evident seal: aluminium foil for orifice seal.

SRT-R19-F	SRT-R19-FH	SRT-R19-T	SRT-R19-T2
Φ19	Φ19	Φ19	Φ19

SRJ-S070-120	G048-050	G050050A	G050080A
ROUND	ROUND	ROUND	ROUND

G050080B	G050080C	G067015	G067020	G067025
OVAL	SQUARE	ROUND	ROUND	ROUND

G106050	G106090	G070010	G070015	G070020
ROUND	ROUND	ROUND	ROUND	ROUND

SRJ-S070-120 / G048

Ref.	OFC (ml)	H. (mm)	L. / W. (mm)	Neck size	Wt
SRJ-S070-120	146	44.2(CAP)	Φ73	70/400	21g
G048-050	65	41.5	Φ50.1	Φ48mm	14g

G067/G106 SERIES

Ref.	OFC (ml)	H. (mm)	L. / W. (mm)	Neck size	Wt
G067015	185	52.5	Φ73	Φ67.5mm	22g
G067020	240	66.5	Φ73	Φ67.5mm	22g
G067025	295	79.5	Φ73	Φ67.5mm	22g
G106050	650	76	Φ110.5	Φ106mm	58g
G106090	1050	115	Φ111.5	Φ106mm	58g

G050 SERIES

Ref.	OFC (ml)	H. (mm)	L. / W. (mm)	Neck size	Wt
G050050A	69	36	Φ59	Φ50mm	16g
G050080A	100	43	Φ63.5	Φ50mm	16g
G050080B	100	43	68x59	Φ50mm	16g
G050080C	100	43	59.7x59.7	Φ50mm	16g

G070 SERIES

Ref.	OFC (ml)	H. (mm)	L. / W. (mm)	Neck size	Wt
G070010	139	39.7	Φ73	Φ70mm	21g
G070015	189	51.7	Φ73	Φ70mm	21g
G070020	239	63.7	Φ73	Φ70mm	21g



G070025 GA030 GA050 GA070100A GR-130A



GR-150A GR-200A GR-250A GR-300A GR-300B



G50068 GU-150B GU-200A GU-200C GUK-200



G070 SERIES

Ref.	OFC (ml)	H. (mm)	L. / W. (mm)	Neck size	Wt
G070025	289	76	Φ73	Φ70mm	21g

GA SERIES

Ref.	OFC (ml)	H. (mm)	L. / W. (mm)	Neck size	Wt
GA030	58	39.5	Φ76.2	Φ70mm	21.5g
GA050	78	39.5	Φ76.2	Φ70mm	21.5g
GA070100A	150	39.5	Φ76.2	Φ70mm	21g

GR SERIES

Ref.	OFC (ml)	H. (mm)	L. / W. (mm)	Neck size	Wt
GR-130A	208	37	Φ91.7	Φ90mm	27g
GR-150A	220	39.5	Φ91.7	Φ90mm	27g
GR-200A	270	47.1	Φ91.7	Φ90mm	27g
GR-250A	320	54.9	Φ91.7	Φ90mm	30g
GR-300A	370	62.5	Φ91.7	Φ90mm	30g
GR-300B	370	69.8	Φ91.7	Φ90mm	30g

G / GU / GUK SERIES

Ref.	OFC (ml)	H. (mm)	L. / W. (mm)	Neck size	Wt
G50068	84	43.9	Φ59	Φ50mm	16g
GU-150B	188	57.9	Φ73	Φ70mm	21g
GU-200A	238	50	Φ85.4	Φ70mm	21g
GU-200C	239	50	Φ90	Φ70mm	21g
GUK-200	239	47.7	Φ90	Φ70mm	21g

SAN/ PETG JAR

ONLY SAN JAR



G-C050070 G-C050090 SRJ-S089-200B SRJ-S089-300 SRJ-S089-350B



PP JAR



DSG-35A G057050 GZ-EC-22 PP250 JCC-400



ABS JAR

ALUMINUM JAR



GZ-050-010 SRJ-VS048-025



G-C050 SERIES

Ref.	OFC (ml)	H. (mm)	L. / W. (mm)	Neck size	Wt
G-C050070	84	41.7	Φ61.9	Φ50mm	16g
G-C050090	106	48.7	Φ63.86	Φ50mm	16g

PETG SERIES

Ref.	OFC (ml)	H. (mm)	L. / W. (mm)	Neck size	Wt
SRJ-S089-200B4	230	46	Φ90.1	Φ88.6mm	68.5g
SRJ-S089-350B5	380	75	Φ90.1	Φ88.6mm	110g

SAN SERIES

Ref.	OFC (ml)	H. (mm)	L. / W. (mm)	Neck size	Wt
SRJ-S089-200B4	230	46	Φ90.1	Φ88.6mm	56.7g
SRJ-S089-200B3	235	49	Φ90.1	Φ88.6mm	75.2g
SRJ-S089-300	329	64.5	Φ92.3	Φ89mm	82.5g
SRJ-S089-350B5	380	75	Φ90.1	Φ88.6mm	92g
SRJ-S089-350B2	375	75	Φ90.1	Φ88.6mm	111.7g

SRJ-S089-200B3 & SRJ-S089-350B2 ARE THICK WALL STYLE

PP SERIES

Ref.	OFC (ml)	H. (mm)	L. / W. (mm)	Neck size	Wt
DSG-35A	43.7	41.2	Φ55	Φ51.8mm	17g
G057050	76.5	35	Φ59.7	Φ57mm	11.5g
GZ-EC-22	83	28.7	Φ73	Φ70mm	17g
PP250	295	42.7	Φ103.6	Φ103mm	26.6g
JCC-400	443	70.1(CAP)	Φ103	Φ89mm	31g

ABS

Ref.	OFC (ml)	H. (mm)	L. / W. (mm)	Neck size	Wt
GZ-050-010	10	21.1	Φ50.5	Φ50mm	17.3g

ALUMINUM

Ref.	OFC (ml)	H. (mm)	L. / W. (mm)	Neck size	Wt
SRJ-VS048-025	28	16.5	Φ48.4	Φ48mm	4.6g



KJ-200C KJ-300C KJ-450C KJ-600C KJ-150DS KJ-200DS



KJ-350DS KJ-500DS KJ-150H KJ-200H KJ-350H KJ-500H



KJ-(A)
Easy-Leakproof Screwable
Kilner Jar



KJ-(B)
Uni-leakproof Screwable
Kilner Jar



KJ SERIES

Ref.	OFC (ml)	H. (mm)	L. / W. (mm)	Neck size	Wt
KJ-200C	297	62.9	Φ79.5	Φ73mm	46g
KJ-300C	369	78.8	Φ79.5	Φ73mm	46g
KJ-450C	565	78.9	Φ98	Φ93mm	65g
KJ-600C	715	95.7	Φ98	Φ93mm	65g
KJ-150DS	213	60.1	Φ79	Φ73mm	46g
KJ-200DS	264	72.5	Φ79	Φ73mm	46g
KJ-350DS	454	80.5	Φ95.9	Φ93mm	65g
KJ-500DS	593	102.4	Φ95.8	Φ93mm	65g
KJ-150H	228	55.3	Φ84	Φ73mm	46g
KJ-200H	278	62.7	Φ86	Φ73mm	46g
KJ-350H	464	72.8	Φ100	Φ93mm	65g
KJ-500H	614	88.3	Φ103	Φ93mm	65g

Inner Plug for Kilner Jar



- ▶ LDPE inner plug
- ▶ Extends product shelf life
- ▶ Fits Dia. 76 Kilner Jar



KS-200A KS-350A KS-500A KS-200B KS-350B



KS-500B KS-150C KS-200C KS-400C KS-150D



KS-200D KS-350D KS-500D KS-150DS KS-200DS



KS SERIES

Ref.	OFC (ml)	H. (mm)	L. / W. (mm)	Neck size	Wt
KS-200A	250	65.4	78x78	Φ76mm	46g
KS-350A	441	75.5	93.5x93.5	Φ93mm	72g
KS-500A	590	80.5	100x100	Φ93mm	72g
KS-200B	250	79	Φ78	Φ76mm	46g
KS-350B	447	91.8	Φ93.5	Φ93mm	72g
KS-500B	591	118.5	Φ93.5	Φ93mm	72g
KS-150C	209	52.9	78x78	Φ76mm	46g
KS-200C	257	62.5	78x78	Φ76mm	46g

Ref.	OFC (ml)	H. (mm)	L. / W. (mm)	Neck size	Wt
KS-400C	509	78.5	94x94	Φ93mm	72g
KS-150D	157	50.3	Φ78	Φ76mm	46g
KS-200D	252	71.5	Φ78	Φ76mm	46g
KS-350D	441	79.7	Φ93.5	Φ93mm	72g
KS-500D	591	104.1	Φ93.5	Φ93mm	72g
KS-150DS	158	50.3	Φ78	Φ76mm	46g
KS-200DS	258	71.5	Φ78	Φ76mm	46g

Kilner Jar Spec Guide

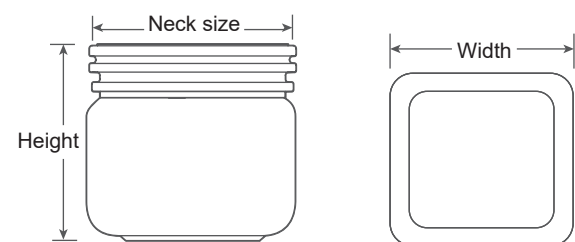

R&D center, production base of EBM Airless

Taiwan | HQ & factory | SR Packaging Inc.

+886 4 2531 6216
No. 550, Sishih Rd.
Fengyuan Dist. Taichung 42077
sales@srpackaging.com

One-stop production from molding to decoration

China | factory | Shanghai SR Packaging
Technology Co., Ltd.

+86 21 5757 7631
Building 2, No. 585 Pinglin Rd.
Zhelin Town, Fengxian District
Shanghai 201416

Made-in-America tube & PET bottle supply

USA | factory | SR Packaging
North America Inc.

+1 610-778-0038
6670 Grant Way
Allentown
PA 18106

Project development and sales support

Japan | office | SR Packaging Inc.

+81 80 7499 2659
4-16-2 Shiba
Minato-ku
Tokyo 108-0014

